

# USER MANUAL



Thank you for choosing Better Bathrooms.  
Please read this manual before installing your product  
and keep for future reference.

**better**   
**bathrooms**

**Empire 500x750mm Arch Mirror - Satin Chrome**

**Empire 500x750mm Arch Mirror - Matt Black**

**Empire 500x750mm Arch Mirror - Matt Black**

**BeBa\_27004 BeBa\_27005 BeBa\_27006**

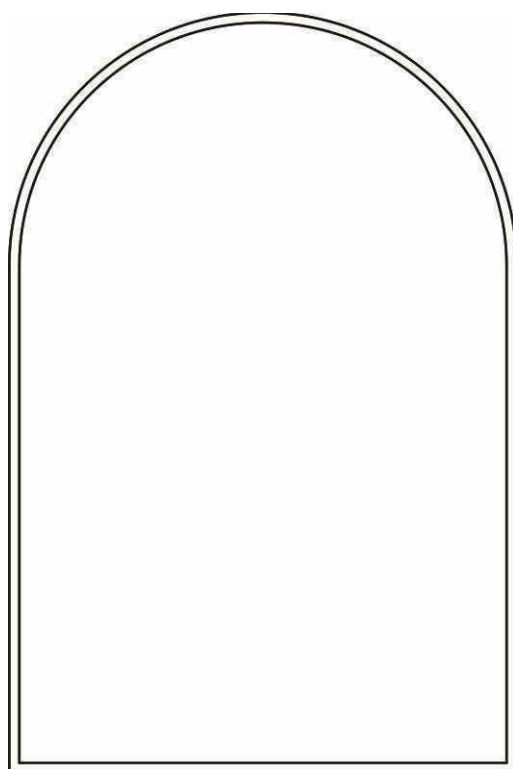

- **Single-person assembly**
- **Tools required**
- **We always recommend using professional tradespeople to install your product**

V1\_03.25.2021

# Congratulations on your purchase

*And welcome to our growing gang of savvy shoppers*

We're on a mission to bring you extraordinary bathroom products, for less. From modern to traditional style ceramics, plus the gorgeous fixtures, fittings and furniture to match. So, you can fall in love with your space every single day.

As one of the UK's largest independent bathroom stores, we've received countless awards; including the National Business Awards UK, the Digital Entrepreneur Awards and being placed on The Sunday Times Fast Track 100.

We hope your new product exceeds your highest expectations. However, if you experience any problems, please:

- call our friendly UK call centre on **03303903062** (9am-7pm Monday to Friday, or 10am-4pm Saturday and Sunday), or
- send us a message via **customerservices@buyitdirect.co.uk**

## Important information

- Please read these instructions thoroughly and retain for future reference
- Always check for pipes and cables before drilling walls

## Parts / Diagrams

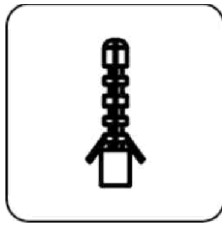

WALL PLUGS (X3)



SCREWS M4(X3)

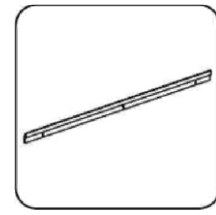

HANGING BAR

PLEASE NOTE :It is the installers responsibility to ensure that the fittings are suitable for the type of wall. Alternative fittings may be required (Not Supplied). If unsure professional advice should be sought.

## Tools required

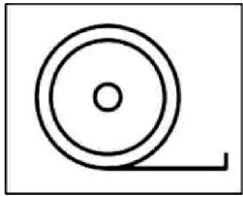

TAPE MEASURE

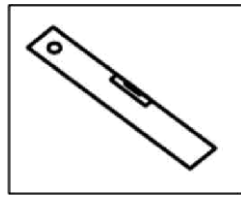

SPIRIT LEVEL

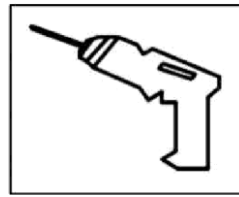

ELECTRIC DRILL

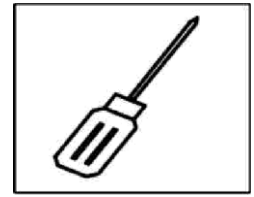

SCREWDRIVER

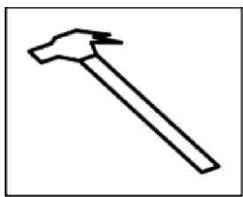

HAMMER

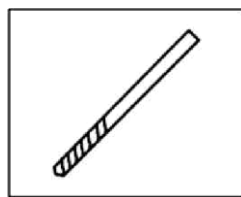

8mm DRILL BIT

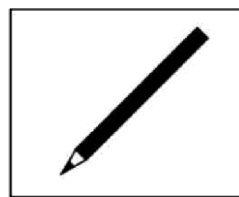

PENCIL

# Installation (drawings for illustration purposed only)

The mirror is supplied with a hanging bar to mount the mirror onto the wall. At the back of the mirror there is a corresponding bar which is designed to slot onto hanging bar. Before attempting installation, the mirror should be unpacked and inspected for signs of damage.

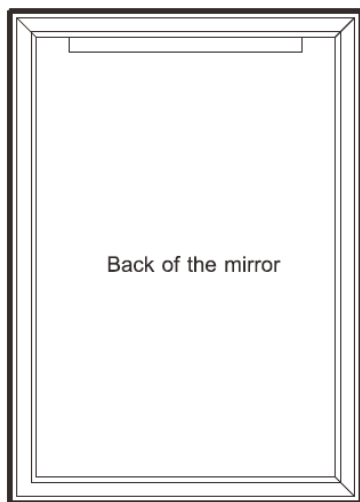

1. Choose the desired position of the mirror and from that determine the required position of the hanging bar.
2. Hold the hanging bar in position, using a spirit level to ensure it is level.

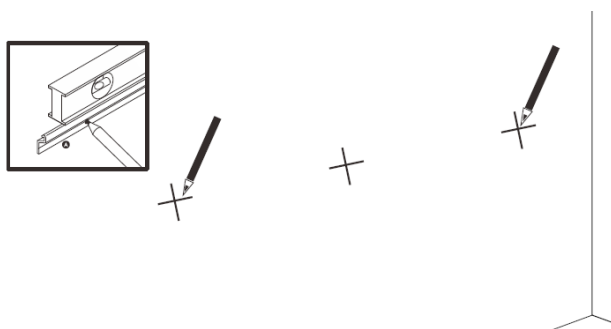

3. Use a pencil to mark the position of the 3 holes.
4. Place the hanging bar to one side, and drill the holes with an 8mm drill bit suitable for the type of wall.

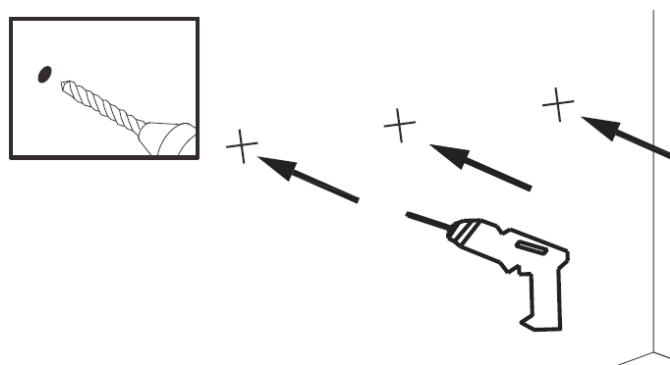

5. Insert wall plugs into the holes, ensuring they are flush to the wall.

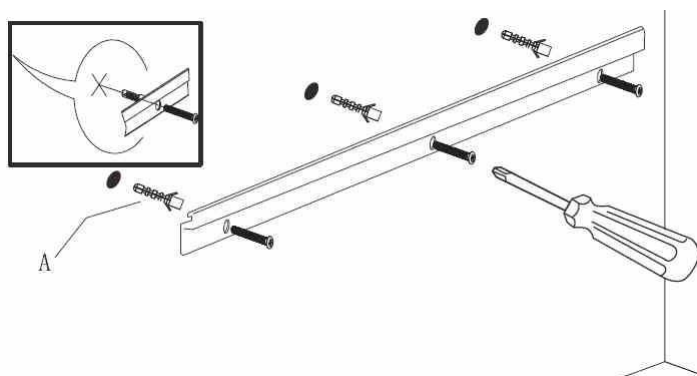

6. Place the hanging bar back onto the wall, lining up the 3 holes with the wall plugs.



7. Secure the hanging bar to the wall using the supplied screws.

8. You will now be able to hang the mirror. Carefully lower the mirror onto the hanging bar, ensuring that it is secure and will not slide.

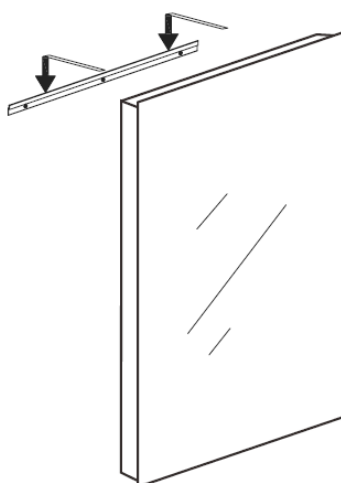

# CLEANING AND MAINTENANCE

Never use products containing bleach or abrasive cleaners, as these will have a detrimental effect on the appearance and lifespan of the product. Use a clean micro fiber cloth to clean the mirror.

## ***For more information***

- visit [betterbathrooms.com](http://betterbathrooms.com)
- email [customerservices@buyitdirect.co.uk](mailto:customerservices@buyitdirect.co.uk)
- call 03303903062
- write to Trident Business Park, Neptune Way, Huddersfield, HD2 1UA

**better**   
**bathrooms**

Part of the BuyItDirect Group