

USER MANUAL



Thank you for choosing Better Bathrooms.
Please read this manual before installing your product
and keep for future reference.

**better
bathrooms**

Non-Illuminated Mirrors

BeBa_24913, BeBa_24914, BeBa_24915

BeBa_25541, BeBa_25542, BeBa_25543,

BeBa_25544

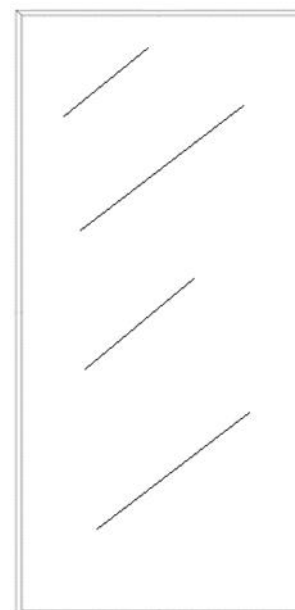
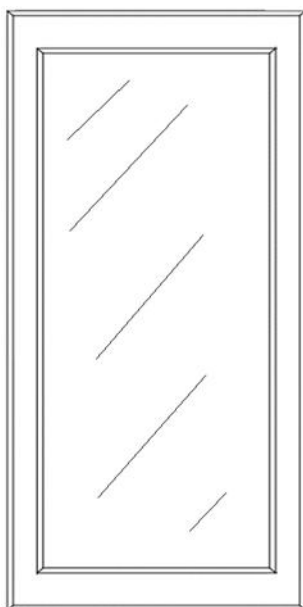
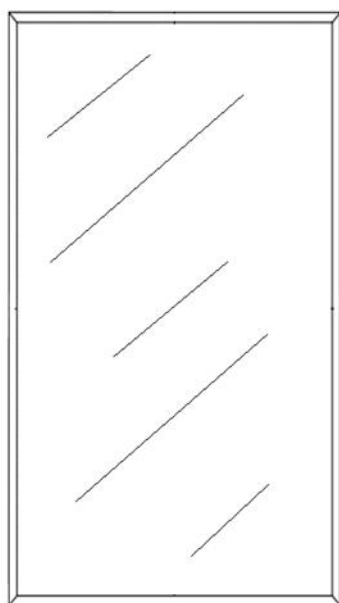

- **Single-person assembly**
- **We always recommend using professional tradespeople to install your product**

V1_30.10.2020

Congratulations on your purchase

And welcome to our growing gang of savvy shoppers

We're on a mission to bring you extraordinary bathroom products, for less. From modern to traditional style ceramics, plus the gorgeous fixtures, fittings and furniture to match. So, you can fall in love with your space every single day.

As one of the UK's largest independent bathroom stores, we've received countless awards; including the National Business Awards UK, the Digital Entrepreneur Awards and being placed on The Sunday Times Fast Track 100.

We hope your new product exceeds your highest expectations. However, if you experience any problems, please:

- call our friendly UK call centre on **03303903062** (9am-7pm Monday to Friday, or 10am-4pm Saturday and Sunday), or
- send us a message via **customerservices@buyitdirect.co.uk**

Important information

- Please read these instructions thoroughly and retain for future reference
- Always check for pipes and wires before drilling the wall

Parts

Mirror x 1

Wall Screws x 3

Wall Plugs x 3

Only two screws and plugs are required for the installation

Tools required

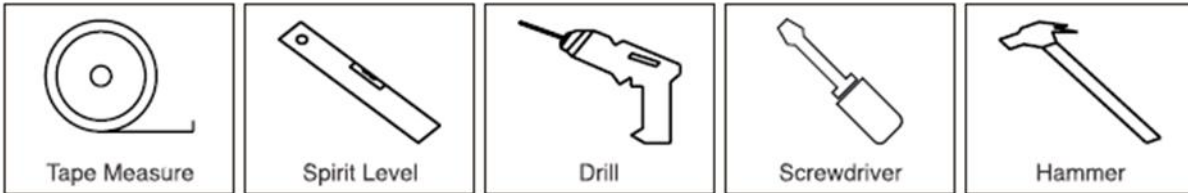

Installation – Check the product for damage prior to installation

Before any drilling is carried out, please check for pipes and wires within the wall which could be damaged.

Decide upon the hanging orientation of the mirror and measure between the fixing points on the back of the mirror.

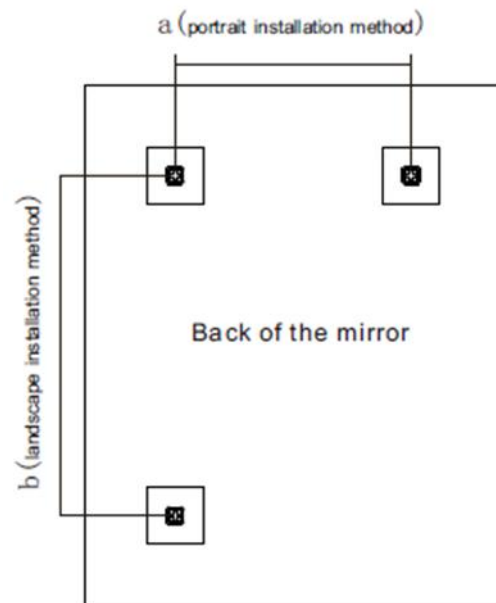
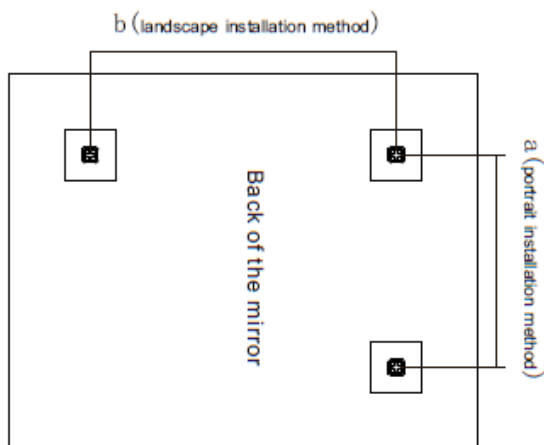

Mark this dimension on the wall, ensuring the holes are level, using a spirit level.

Drill the wall at the marked points on the wall for your required orientation and insert the wall plugs and tap until flush with the finished wall surface.

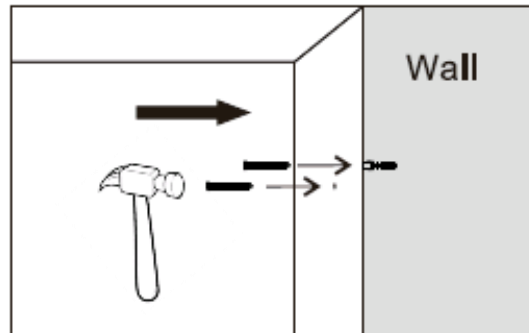
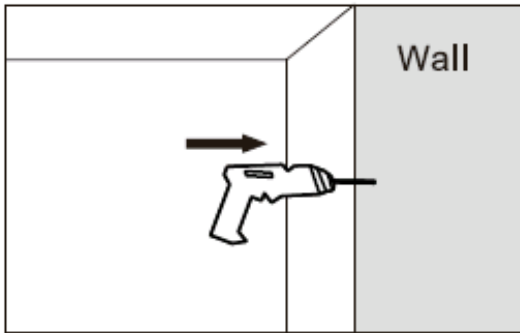

After fitting the wall plugs, insert the screw and tighten, DO NOT tighten the screw fully to the wall surface.

Tighten the screw until it is between 2 -4 mm from the wall surface, as shown below.

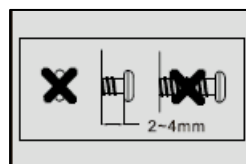
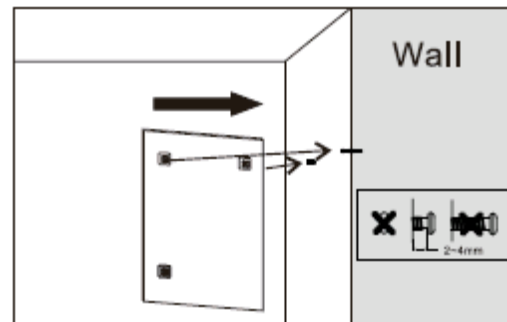
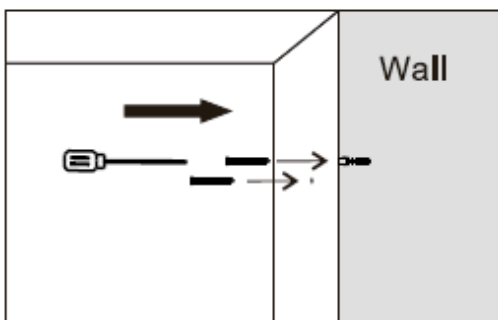

When the screw is correctly located, offer the rear of the mirror to the wall to engage the bracket onto the screws.

When the bracket is hooked onto the screw gently push down on the mirror to secure the mirror bracket fully onto the screw, as shown below.

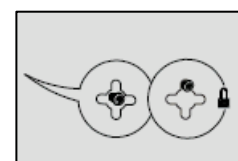
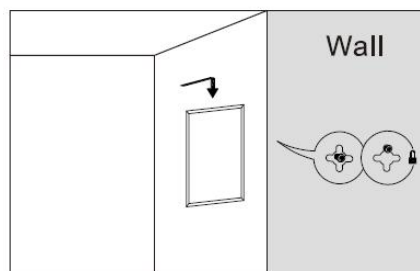
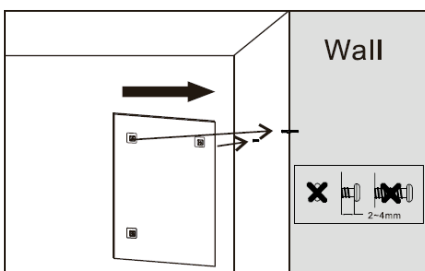

Cleaning

Wipe the mirror clean and dry regularly, especially when the mirror is subject to steam or splashes.

Do not use harsh chemicals or materials on the product, as this will damage the product and invalidate your guarantee.

To clean and maintain the product, wipe using a clean damp cloth and wipe dry with a soft cloth.

For more information

- visit betterbathrooms.com
- email customerservices@buyitdirect.co.uk
- call 03303903062
- write to Trident Business Park, Neptune Way, Huddersfield, HD2 1UA

better 
bathrooms

Part of the BuyItDirect Group

